

Barbie™

Switchboard™

*Please keep this instructions sheet for future reference,
as it contains important information.*

No adult assembly is required.

Adult assistance is required to adjust the handle up or down.

Ages 5 - 7 years. Weight Limit: 100 lbs. (45 kg).

Protective equipment shown in these photos is not included.

Scooter



Skateboard



Product Number: B1613, B1614



Discover what's possible™... www.fisher-price.com

Safety Tips

WARNING

To prevent injury:

- Keep away from cars, streets, steep inclines, steps, swimming pools or other bodies of water.
- Protective equipment should be worn. Use helmet, wrist guards, knee pads and elbow pads.
- Always wear shoes.
- Never allow more than one (1) rider.
- Never ride at night.

IMPORTANT! Please take a few moments to review the following safety tips with your rider.

- Be sure an adult adjusts the handle up for scooter use and down for skateboard use.
- Your rider should wear shoes or sneakers that provide good support.
- Your rider should not wear open-toe shoes.
- Your rider should wear a helmet, knee pads, wrist guards and elbow pads to guard against bumps and bruises.
- Keep loose laces and pant legs away from the wheels.
- Supervise beginners. Hold the beginner's hand and guide the new rider along a smooth, level surface.
- Choose areas for riding that are free of obstacles, and avoid wet or uneven surfaces.
- Make sure your rider never rides on streets, roadways and driveways which enter vehicle traffic routes.
- Towing riders with bicycles or cars is unsafe.

Adjusting the Trucks

The Switch Board™ trucks are adjusted at the factory to the stiffest setting (for beginner use). The stiff setting provides the greatest stability. As your child becomes more comfortable and is better able to balance on Switch Board™, you can adjust the trucks (to a loose setting) to allow greater steering control.

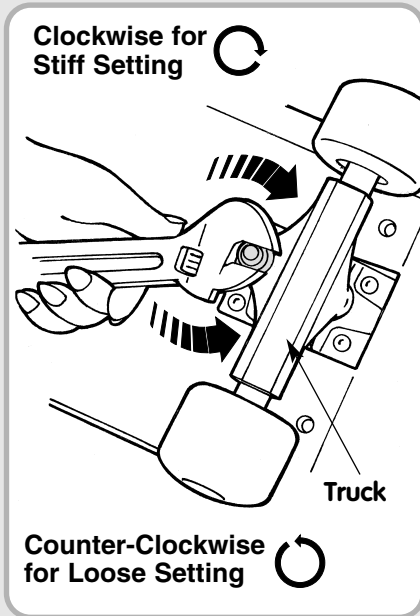

- Turn Switch Board™ upside-down on a flat surface. Locate both trucks on each end of the board.

Hint: Be sure to place a sheet or towel on the surface to protect it.

- Using an adjustable wrench:
 - Turn each nut **clockwise** for a **stiff** setting.
 - Turn each nut **counter-clockwise** for a **loose** setting.

Hint: You should not need to loosen the nut more than a few turns for a loose setting.

IMPORTANT! Check to be sure you have not loosened the trucks too much! Pull on both trucks. The trucks should remain on the board. If you can remove either of them, you have loosened the truck(s) too much. Replace the truck(s) and tighten the nut(s) clockwise with an adjustable wrench.

Scooter

Handle Up

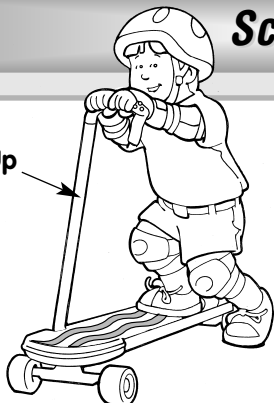

Note: Protective equipment in this illustration is not included with this toy.

1

Handle Up

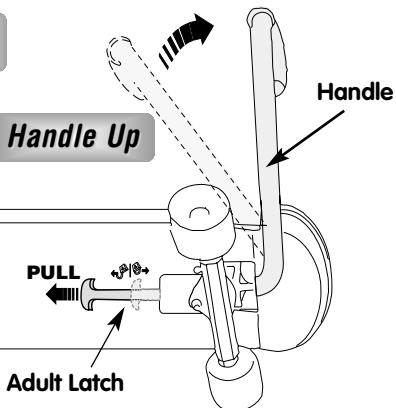

2

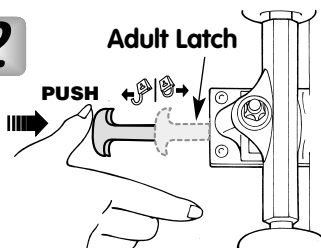

Adult Latch

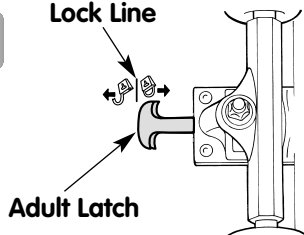

3

Lock Line



- Place Switch Board™ on its side with the handle towards you.
- Pull the adult latch out completely , to unlock the handle. While holding the adult latch out with one hand, pull the handle outward slightly (about two inches) with the other hand. Release the adult latch **1**.
- Continue to rotate the handle to the upright position.
- **Push the adult latch until it “snaps” into place **2**. Make sure you hear a “snap”. The end of the adult latch should align with the lock line  **3**.**
- Position Switch Board™ upright. Push the handle back to be sure it is secure.

Hint: To balance, your rider needs to stand on the center area of the Switch Board™!

Skateboard



Note: Protective equipment in this illustration is not included with this toy.

Handle
Down

2

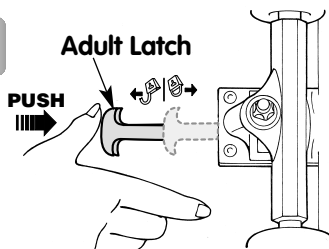

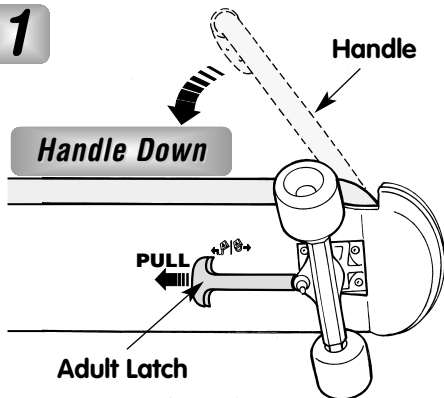

1

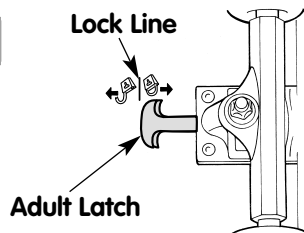

3



- Place Switch Board™ on its side with the handle toward you.
- Pull the adult latch out completely , to unlock the handle. While holding the adult latch out with one hand, push the handle down slightly (about two inches) with the other hand. Release the adult latch **1**.
- Continue to rotate the handle completely down.
- Push the adult latch until it “snaps” into place **2**. Make sure you hear a “snap”. The end of the adult latch should align with the lock line  **3**.**
- Position Switch Board™ upright. Pull the handle up to be sure it is secure.

Hint: To balance, your rider needs to stand on the center area of the Switch Board™!

Care

- Periodically inspect Switch Board™ for wear or damage. Check all nuts and bolts and tighten as required.
- To clean, use a mild soap and water solution and clean cloth. Rinse clean with water to remove soap residue.
- This product has no consumer serviceable parts. Please do not take this product apart.

Consumer Information

Questions? We'd like to hear from you!

If you'd like to order replacement parts, or if you have any questions about this product, please call Fisher-Price® Consumer Relations, toll-free at **1-800-432-5437**, 8 AM - 6 PM EST Monday through Friday. Hearing-impaired consumers using TTY/TDD equipment, please call 1-800-382-7470. Or, write to: Fisher-Price® Consumer Relations, 636 Girard Avenue, East Aurora, New York 14052.

Canada: call 1-800-567-7724, or write to: Mattel Canada Inc., 6155 Freemont Blvd., Mississauga, Ontario L5R 3W2.

Great Britain: telephone 01628 500302.

Australia: Mattel Australia Pty. Ltd., 658 Church Street, Locked Bag #870, Richmond, Victoria 3121 Australia.
Consumer Advisory Service 1300 135 312.

New Zealand: 16-18 William Pickering Drive, Albany 1331, Auckland.